

Installation and operation manual

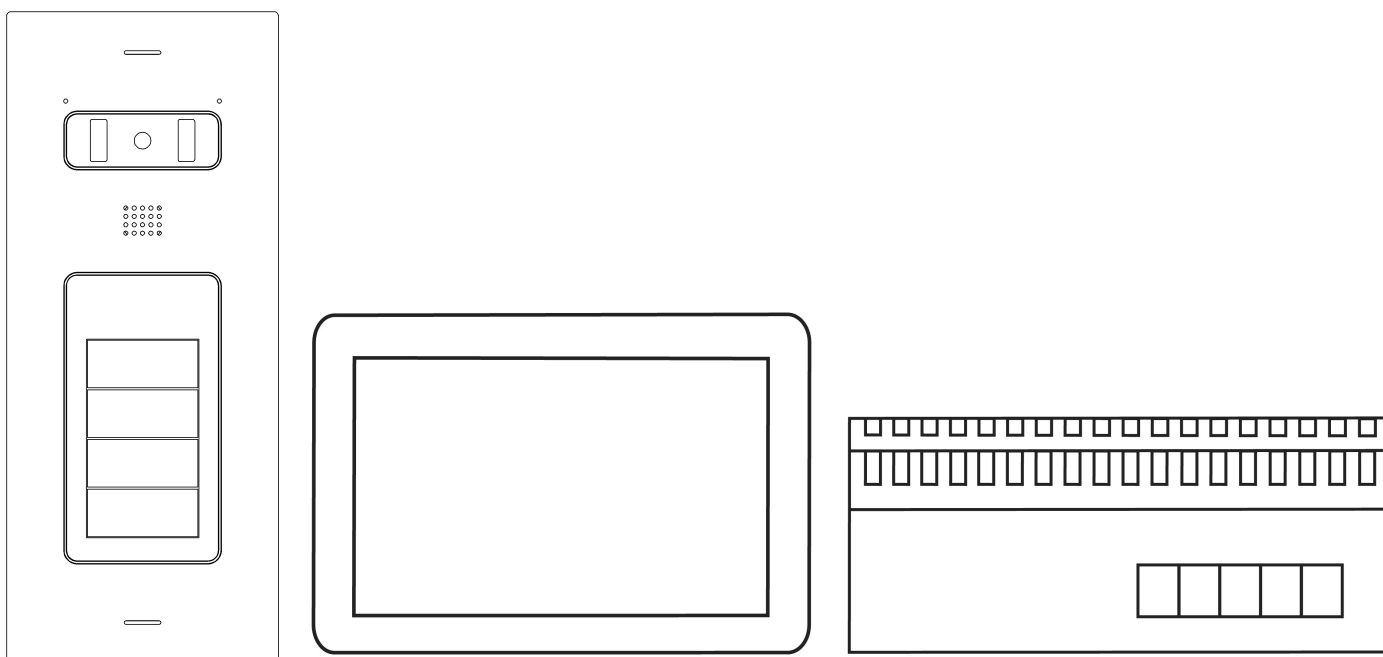

ZK271 - ZK271.40
ZK27D - ZK27D.40



KIT

KIT DESCRIPTION

KIT color video door phone system built on IP technology already configured consisting of:

- 1 audio/video entrance panel made of stainless steel, flush-mount with touch buttons (ZK271 / ZK271.40), or with display (ZK27D / ZK27D.40), complete with 5Mpx color camera
- 1 power supply for DIN rail mounting (the space of 12 DIN modules)
- 1 semi-surface wall-mounted monitor black (ZK271.40 / Z27D.40) ,or white (ZK271 / ZK27D) with color screen TFT LCD 7" WVGA resolution with Android operating system.

Z6001 DESCRIPTION

- Main power supply for INFINITEPLAY audio and video door entry systems.
- **Start-Up Time: 2 minutes to wait for Entrance Panel sound**
- With internet service in the home, you can establish a connection between power supply (P5) and router to see services such as weather, news, directly from videophone.

TECHNICAL CHARACTERISTICS

- Supply Voltage: 100V - 240VAC, 50-60 Hz, 1,8A
- Operating temperature: 0 ° C to +45 ° C
- Polymer housing: ABS V0
- Size: 208x89x60 mm
- Relay Ratings: Max 30VDC - 2A. Non to be used with AC Voltages
- Inputs: Open Collector (Internal Pull-Up)
- Lock Output: 12V @ 1A
- PoE Outputs: IEEE 802.3af Max 12W per port

MANDATORY INSTALLATION REQUIREMENTS ART. Z6001

- Equipment intended for installation in Restricted Access Location performed by specialist technical staff only.

- The installation must comply with National Electrical Code (NEC) (NFPA 70) and other country national electrical codes.

- A readily accessible disconnect device shall be incorporated in the building installation wiring.

- A readily accessible listed branch-circuit over current protective device rated 15A must be incorporated in the building wiring for each power input.

- Main power cables (terminal blocks 1-2-3) must be within 12 to 14 AWG.

- Interconnecting cables used must be UL certified and must be compliant with the CEI 64/8 for video door entry systems:

- UTP CAT 5e for domestic routes dedicated to video door-phone system
- FTP CAT 5e shared routes with tension cables
- UTP CAT 5e for outside with protective sheath in PVC
- All cables must be LSZH for Low Smoke Zero Halogen

- Mounting: this device can be mounted on DIN rail cabinets equipped (12 DIN space modules)

- First to programming read the instructions carefully to get the full picture on the features, functions and performance.

MORSETTI	SERIGRAFIA	DESCRIZIONE	LIMITI
1	N	AC NEUTRO	100-240VAC, 50-60Hz, 1,8Amps
2	-	TERRA	
3	L	AC FASE	100-240VAC, 50-60Hz, 1,8Amps
4	IN1	INGRESSO 1	Ingresso Open Collector (Pull-Up Interno)
5	IN2	INGRESSO 2	Ingresso Open Collector (Pull-Up Interno)
6	IN3	INGRESSO 3	Ingresso Open Collector (Pull-Up Interno)
7	IN4	INGRESSO 4	Ingresso Open Collector (Pull-Up Interno)
8	GND	GND per INGRESSI 1-2-3-4	
9	GND	GND per INGRESSI 1-2-3-4	
10	AUX1	RELAY AUX1 (2A@30VDC)	Max 30VDC - 2Amps
11	C1	COMUNE 1	
12	AUX2	RELAY AUX2 (2A@30VDC)	Max 30VDC - 2Amps
13	C2	COMUNE 2	
14	AUX3	RELAY AUX3 (2A@30VDC)	Max 30VDC - 2Amps
15	C3	COMUNE 3	
16	S-	COMUNE SERRATURA	
17	S-	COMUNE SERRATURA	
18	S+	12VDC 1A SERRATURA	Uscita 12VDC @ 1Amp
19	USB	PORTA USB 2.0	Uscita Max 500mA
20	RS232	PORTA RS-232 DIAGNOSTICA	
21	POWER	LED POWER	
22	P1 LED	LED POE PORTA 1	
23	P2 LED	LED POE PORTA 2	
24	P3 LED	LED POE PORTA 3	
25	P4 LED	LED POE PORTA 4	
26	P5 LED	LED POE PORTA 5	
27	STATUS	LED RBG STATO	
28	-	PLUG PER MODULO	
29	P1	PORTA 1 10/100Mbps	Uscita PoE IEEE 802.3af Max 12W
30	P2	PORTA 2 10/100Mbps	Uscita PoE IEEE 802.3af Max 12W
31	P3	PORTA 3 10/100Mbps	Uscita PoE IEEE 802.3af Max 12W
32	P4	PORTA 4 10/100Mbps	Uscita PoE IEEE 802.3af Max 12W
33	P5	PORTA 5 10/100Mbps	Uscita PoE IEEE 802.3af Max 12W

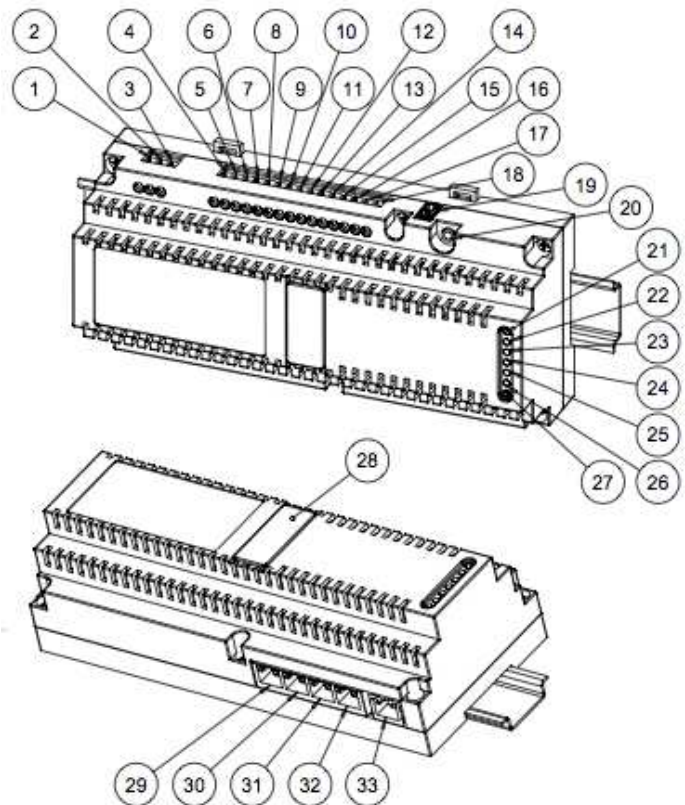

KIT

RJ45 PORTS DESCRIPTION FOR VIDEO DOOR ENTRY SYSTEM CONNECTION

MAIN POWER SUPPLY ART. **Z6001**

Power supply unit PoE for villa or building video door entry system

RJ45 ports:

P1-P2-P3-P4 Dedicated to connecting ENTRANCE PANEL or VIDEO DOOR PHONE

P5 is dedicated to connecting of ROUTER for INTERNET

Z6001

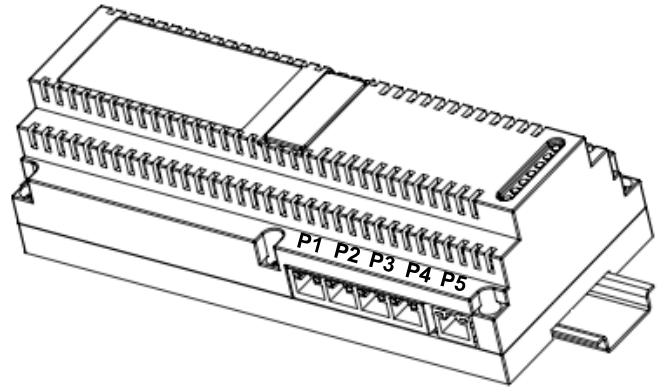

DISTRIBUTOR ON LANDING ART. **Z60DV**

Need to distribute of VIDEO DOOR PHONE

RJ45 ports:

P1-P2-P3-P4-P5 Dedicated to the connection of VIDEO DOOR PHONE

Z60DV

Z60DT

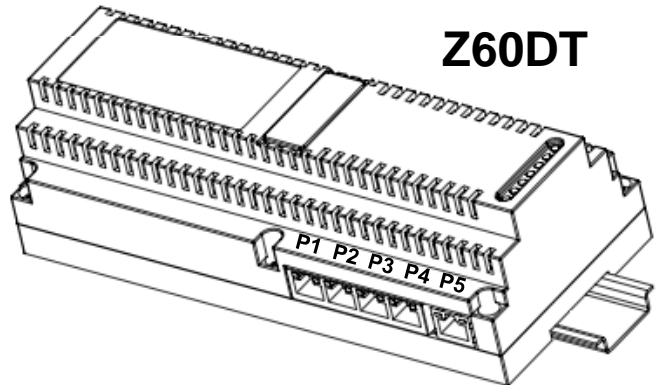

DISTRIBUTOR ART. **Z60DT**

Need to distribute of ENTRANCE PANEL or CONCIERGE STATION

RJ45 ports:

P1-P2-P3-P4-P5 Dedicated to the connection of a ENTRANCE PANEL or CONCIERGE STATION

FIREWALL ART. **Z600F**

If you need to connect to the internet in one of the houses is necessary to insert an internal distributor 4 outputs FIREWALL Art.Z600F (attached diagram)

RJ45 ports:

P1-P2-P3-P4 Dedicated to the connection of ENTRANCE PANEL, VIDEO DOOR PHONE and ROUTER for INTERNET

P5 Input connection to backbone

Z600F

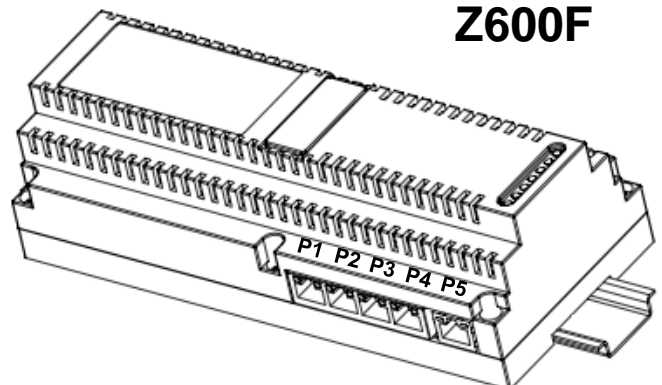

KIT

DESCRIPTION:

Audio-video entrance panel for INFINITEPLAY video door entry systems.

ENTRANCE PANEL INSTALLATION

ART . Z2001 – Z200D

Installing from flush mounted:

- Install back box Art. Z9092 in vertical position at a height of 165 cm from the floor to the top edge, as indicated in the figure.
- Secure the pick springs to the back box using the 4 nuts M3, keeping them aligned plumb with the finish of the exterior wall
- Insert the card names and close the lid on Z2001
- Wire the electronics assembly as shown through the RJ45 connector
- Place the product FLAT within their back box by pressing on the high and low part of it to facilitate the automatic interlocking.

PLEASE NOTE: *The equipment must be directly and permanently mounted on a non-combustible surface such as concrete and metal. Supports or materials with poor self-extinguishing requirements must be excluded.*

Removing the FLAT external unit Z2001 - Z200D:

Take the two keys release in the package

- 1) Insert the key release in the slot (shown in the picture) and press
- 2) Pull out the product FLAT external unit Z2001 - Z200D

Description connection terminal block:

- Line entrance panel with RJ45 connector
 - Interconnecting cables used must be UL certified and must be compliant with the CEI 64/8 for video door entry systems:
 - UTP CAT 5e for domestic routes dedicated to video door-phone system
 - FTP CAT 5e shared routes with tension cables
 - UTP CAT 5e for outside with protective sheath in PVC
- All cables must be LSZH for Low Smoke Zero Halogen

Technical characteristics:

- Brushed stainless steel exterior AISI 316 with ABS frame and glass parts are made from ultra-strong, scratch-proof.
- Ready to install flush mount wall with metal coupling
- The night light is ensured by 4 efficiency LED
- LCD Display 4.3 " and presence sensor in Art. Z200D
- Standby power consumption 7 mA , in conversation : 150mA
- Operating Temperature : -20 ° to 50 ° C
- Dust and Water Resistant - Rating IP54
- **Size : 310x130x2 mm**

Maintenance:

Clean the entrance panel using a soft cloth. Do not use any type of chemical product.

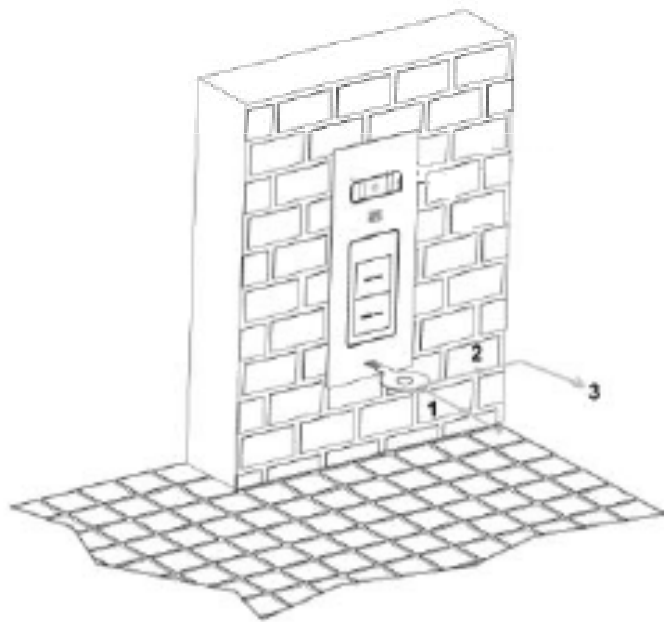
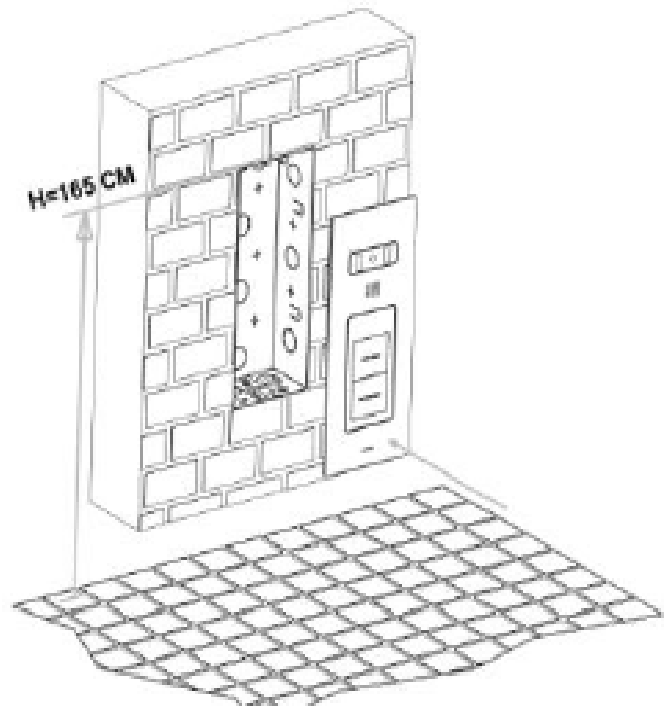

To remove the Entrance Panel use the appropriate extraction key.

Before re-install the Entrance Panel, close the slot using the appropriate stopper, positioning it from the back, as shown in picture below.

Attention: without the stopper the Entrance Panel loses the IP54 class and could be subject to water and dust ingress!

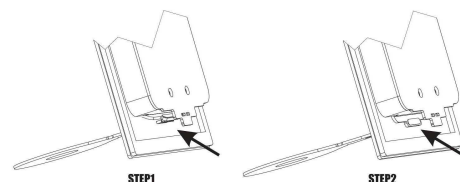

KIT

VIDEO DOOR PHONE INSTALLATION ART. Z7000 / Z7000.40

Installing from semi-surface mounted:

Install the monitor away from sources light and heat.

Install the flush-mounted back box type:

INFINITEPLAY ZT503

Vimar V71303 - V71318

ELVOX 6149

Bticino 503E (horizontal - vertical) – 506E

on the wall at a height of approximately 1.45 m from the floor to the lower edge, as indicated in the figure.

Carry out the wiring according to the wiring diagrams.

Staying the video in the following way: put the monitor on the attachment plate holding it slightly raised at this point by holding down the front make a slight downward pressure

Remove the protective film from the display.

Should it be necessary to remove the video you need to lift (from bottom to top) the video frame by pressing the hook.

Description connection terminal block:

2 - Line video with RJ45 connector

PW+ - Input for additional 12V power supply (if required)

PW- - Mass supplementary feeding

FP-Connection for door call button with reference to M

AL - General alarm apartment with reference to M

P - Panic button user with respect to M

M - Mass

CH1 - Relay additional chime

CH2 – Relay additional chime

USB

Interconnecting cables used must be UL certified and must be

compliant with the CEI 64/8 for video door entry systems:

UTP CAT 5e for domestic routes dedicated to video door-phone system

FTP CAT 5e shared routes with tension cables

UTP CAT 5e for outside with protective sheath in PVC

All cables must be LSZH for Low Smoke Zero Halogen

Technical characteristics:

- Semi-surface mounted of ABS, glass parts are made from ultra-strong, scratch-proof.
- Ready for installation by Semi-surface mounted with metal coupling
- LCD 7 "capacitive touch screen
- Video Signal WVGA 800X480 Cr 500
- PoE alimentation
- Standby power consumption 7 mA, in conversation: 150mA
- Operating Temperature: 0 ° to 40 ° C
- Electronic chime
- Input for door call.
- Size: 189x119x21 mm

Maintenance:

Clean the monitor using a soft cloth, which can be dry or slightly dampened with water. Do not pour water directly onto the screen and do not use any type of chemical product.

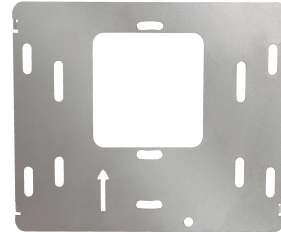

7"



H= 145-150 cm



KIT

MATERIAL NEEDED:

- 1 skein of CAT5 Ethernet cable UL certified
- Connectors RJ45 plug UL certified
- 1 scissor
- 1 crimping tool 8-pin
- Recommended a tester for checking LAN cables

MAKE A STRAIGHT CABLE

PIN	Code color T568B
1	 White orange
2	 Orange
3	 White green
4	 Blue
5	 White blue
6	 Green
7	 White brown
8	 Brown

PROCEDURE:

- 1) SKINNING CABLE (25-30 mm)
- 2) ORDER cable as shown and line-up , cutting the connectors with scissors at the same height (about 10mm)
- 3) INSERT THE CABLE IN CONNECTOR RJ45 as shown in figure
- 4) CRIMPING WIRE with clamp
- 5) FINAL CHECK OPERATION with tester

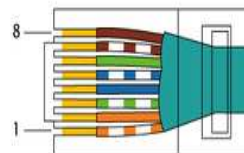
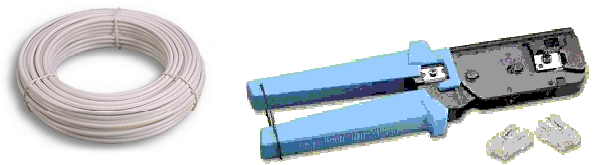

EIA/TIA-568B

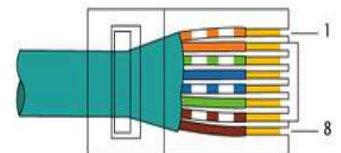

EIA/TIA-568B

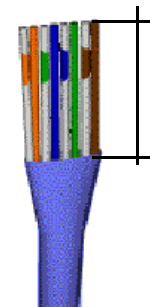
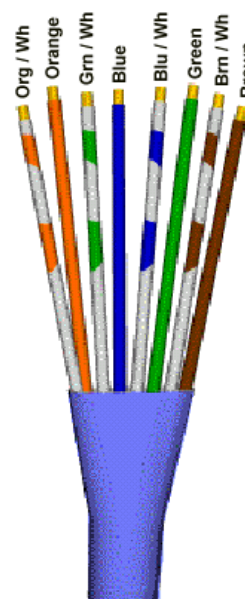

Altezza
10mm

KIT

SYSTEM PROGRAMMING

There are two types of configurations:

1) Using an internal video door when you first start is recommended for small building

2) For systems of higher dimensions can be a system configuration from a PC by software
To be connected PC to any RJ45 port of InfinitePlay system by patch cords.

IIP SETUP INSTALLER:

KEY PASSWORD: 000000

Setup by video door phone

VIDEO DOOR PHONE ID (ten digit code):

Building 01
Floor 103
Apartment 050
Internal device 04

PHASES OF CONFIGURATION:

The configuration steps of the system are divided into only 5 points:

1. BASIC SETTINGS
2. ENTRANCE PANEL
3. POWER SUPPLY
4. VIDEO DOOR PHONE
5. MAPPING ENTRANCE PANEL

1. BASIC SETTINGS

To be programmed the basic parameters for system

- CONCIERGE (yes / no)
- SOS PANIC BUTTON (yes / no)
- VIDEO DOOR PHONE VISIBILITY SYSTEM(all video intercom device/ only master video intercom device)
- SYSTEM SETTING TIME (GMT 00)
- SETUP INFINITEPLAY SYSTEM LANGUAGE
- CHANGE PASSWORD OF SYSTEM (default 000000)

2. ENTRANCE PANEL

To be programmed all parameters of entrance panel in the system

IDENTIFICATION NUMBER (Mac address out door unit)=
B4669800F3

CUSTOM ID NUMBER: from 1 to 200 unit

NAME ENTRANCE PANEL: Regent St

SUBTYPE: Choose the subtype of call (1-4 touch buttons, list on LCD display, buttons on LCD display)

ANSWER TIME (1 to 255 s)
Default value 30 s

CONVERSATION TIME (1 to 255 s)
Default value 120 s

SELF-START TIME(1 to 255 s)
Default value 30 s

AUDIO INDOOR-OUTDOOR (0% to 100%)
Default value 50%

ENTRANCE PANEL RINGTONE REPETITION (yes / no)
Default value is yes

SAVE SETTINGS BEFORE YOU GET OUT OF SETUP

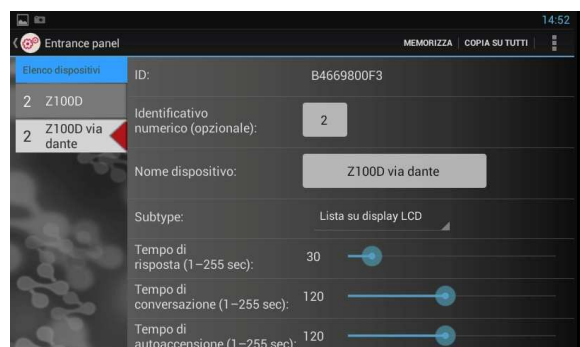
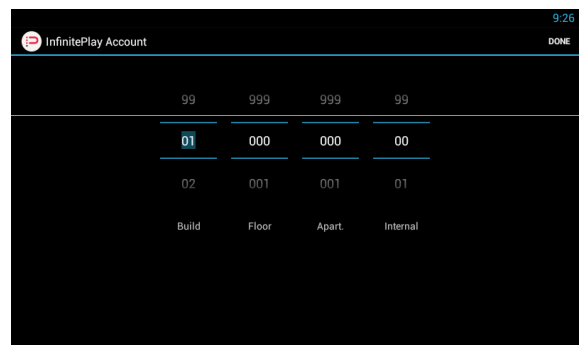
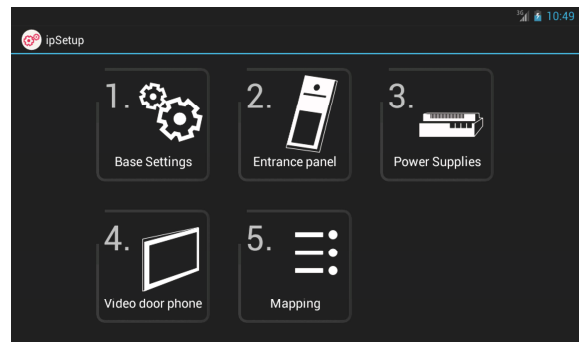
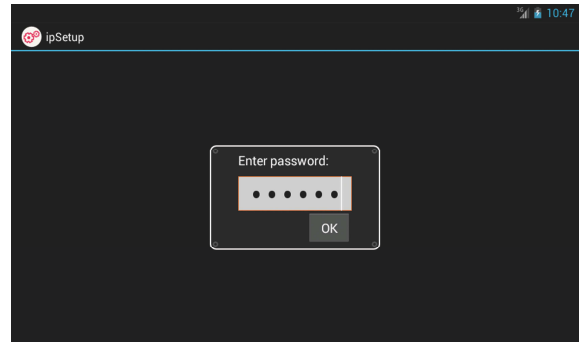

BACK

SAVE



KIT

3. POWER SUPPLY

A video door phone INFINITEPLAY system can contain only one server SIP Z6001 and several distributors Z60DT

IDENTIFICATION NUMBER = 0000000000

DEVICE NAME: es: Z6001 Main electrical panel

OUTPUT

FUNCTION:

To be assign one of the following functions that appear in the video intercom. If you have an "X" the function is disabled.

CODE:

You can assign an identification number to each OUTPUT activated by outdoor unit with display. code set preceded by # symbol (eg. # 123)

TIMEOUT:

The time of OUTPUT can be programmed

TIME LOCK: (from 1 to 30s) default value 1s

TIME AUX1: (from 1 to 30s) default value 1s

TIME AUX2: (from 1 to 30s) default value 1s

TIME AUX3: (from 1 to 30s) default value 1s

ENTRANCE PANEL:

Through "entrance panel" binds the selected function to one or more entrance panel present in the system.

To a call from entrance panel will be displayed one priority function.

LINK:

This parameter enables indirect opening of the lock, at the same time as the opening of the lock of another entrance panel, at the command of an interphone/monitor interphone. Indirect opening can be associated with different entrance panels.

For example: LOCK type Z6001 (1) with LOCK type Z60DT (2).

When you press lock push button, will operate both entrance panel at same time by their respective power supplies.

INPUTS

Module type Z6001 receives the command from four N/O push button and when closing, they send the messages to output. (ex. Light stair push button)

INPUT CALL allows you to make a call from an entrance panel to an indoor video door phone.

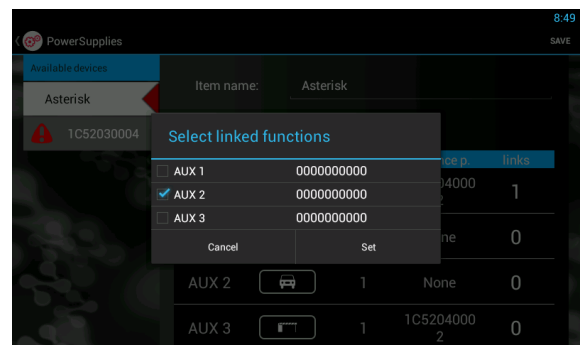
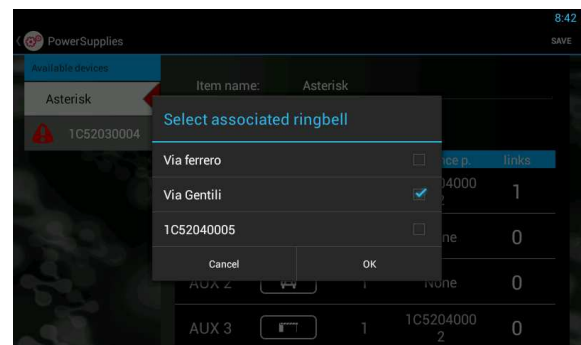
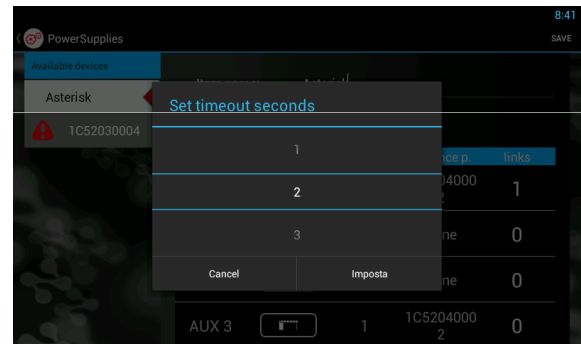
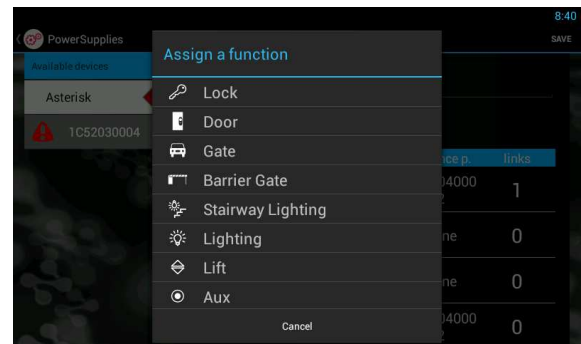
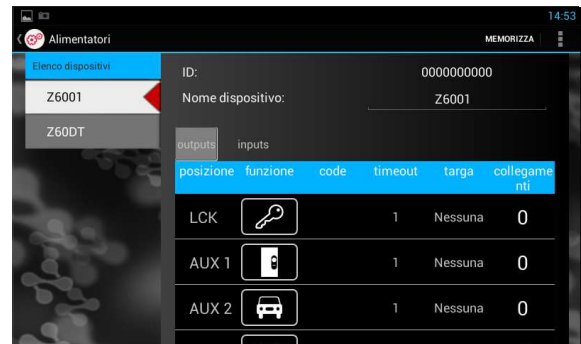

SAVE SETTINGS BEFORE YOU GET OUT OF SETUP

KIT

4. VIDEO DOOR PHONE

At the first installation is requested the physical position of the device:

PROGRAMMING ID IDENTIFICATION CODE

Building 01
 Floor 103
 Apartment 050
 Internal device 04

In the INFINITELAY kits the monitor ID CODE :
01 000 001 00

USER NAME: (ex. Famili Briyan)

The name will appear in the display entrance panel Art.Z100D – Z200D
 The name will appear in the intercom contacts

VISIBILITY ENTRANCE PANEL:

You can select the list of entrance panels that can call this device.
 Default all entrance panels call everyone users

FILTER FUNCTIONS AVAILABLE:

At the request of a end user, you can disable an auxiliary function that is also used by other residents

VISIBILITY VIDEO DOOR PHONE:

With this function you can define the visibility of the indoor unit intercom

1) INTERNAL INTERCOM CALLS

Select the list of all internal devices apartment that you can call

2) EXTERNAL INTERCOM CALLS

Select the list of the internal intercom of the building that you can call

DOCTOR MODE: (yes/no)

When a call comes in this monitor sends the command lock automatically on power supply.

AUTO ANSWER: (yes / no)

By activating this function, the indoor unit will enter into conversation with the outdoor unit automatically after a few seconds

INTERCOM GROUPS:

With this function you can define a group of calls by choosing the origin of the call. (Eg. To join an indoor unit slave with his master)

1) TO CALL FROM EXTERNAL UNIT

2) TO CALL FROM INDOOR UNIT INTERNAL TO THE APARTMENT

3) TO CALL FROM INDOOR UNIT EXTERNAL TO THE APARTMENT

ECHO CANCELLATION:

With this function you can choose the degree of noise cancellation of your INDOOR UNIT device InfinitePlay.

- 1) Normal (recommended by the factory)
- 2) hard
- 3) strong

SAVE SETTINGS BEFORE YOU GET OUT OF SETUP

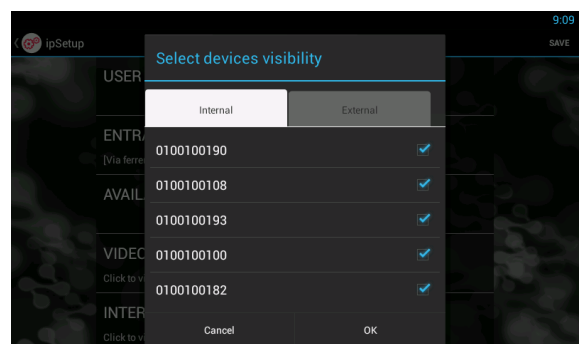
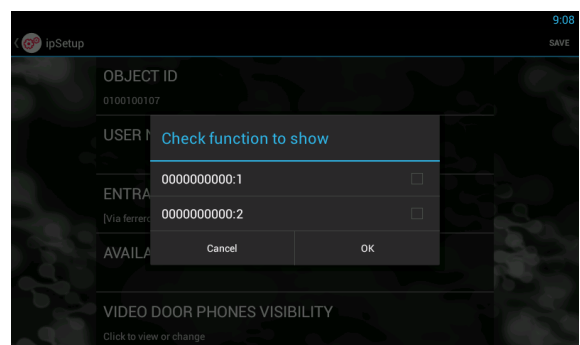
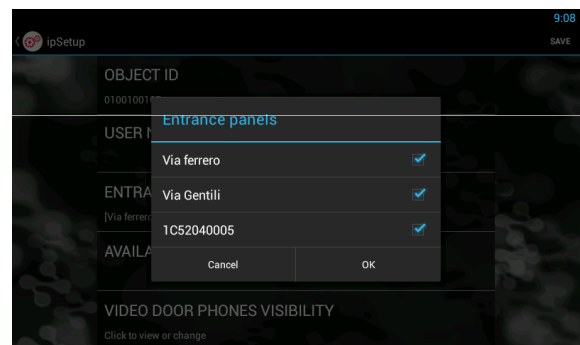
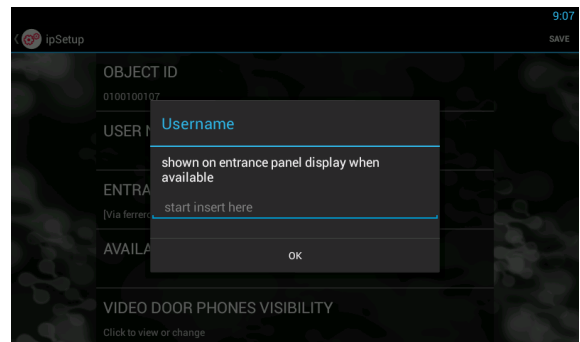
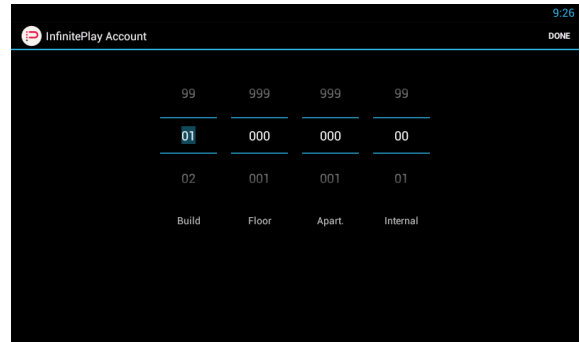

KIT

5. MAPPING ENTRANCE PANEL

ENTRANCE PANEL SETUP

Select the entrance panel to set their parameters (touch push button or display)

ENTRANCE PANEL TOUCH BUTTONS Z1001-Z2001

If in the presence of a outdoor unit touch buttons must be set:
TOUCH BUTTONS 1 call the indoor unit 01000001000 - Famili Briyan

ENTRANCE PANEL TOUCH DISPLAY Z100D-Z200D

If in the presence of a outdoor unit display must be set:

PROPERTY LOGO: In JPG format

PANEL RINGTONE REPEAT (sound/ring.mp3) suggested

VOLUME ENTRANCE PANEL (from 0% to 100%)
Default value 20% suggested

STAUTS MESSAGE (yes/no)

If you set YES the entrance panel show messages
(Calling, in conversation, door lock opened, end the conversation)

ENABLE ANIMATION (yes/no)

With this function activates an animation in the outdoor unit display that ease the visitor in the use of the outdoor device

SHOW CODE BUTTON (yes/no)

Using this function enables the possibility to activate an automation from the outdoor unit by code (ex.#123)

ENABLE RECEPTION BUTTON (yes/no)

With this function you enable a button dedicated to the call of concierge station.

BUILDING NAME: (ex.Residence Argenta)

STREET NUMBER: (ex. 26 2B)

WELCOME MESSAGE

ALTERNATION MESSAGE

TIME ALTERNATION: Settable in seconds

SAVE SETTINGS BEFORE YOU GET OUT OF SETUP

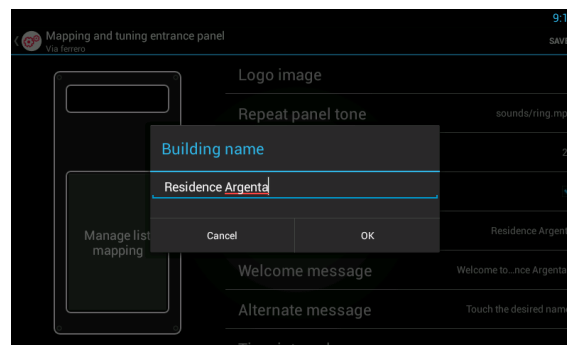
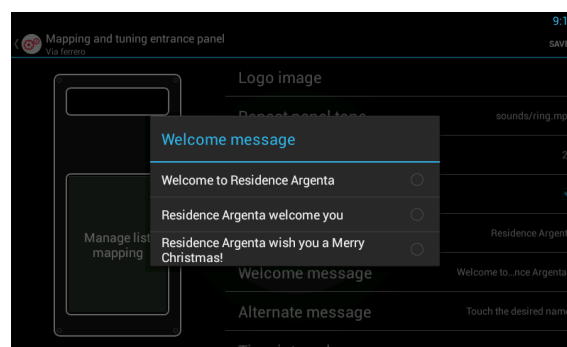
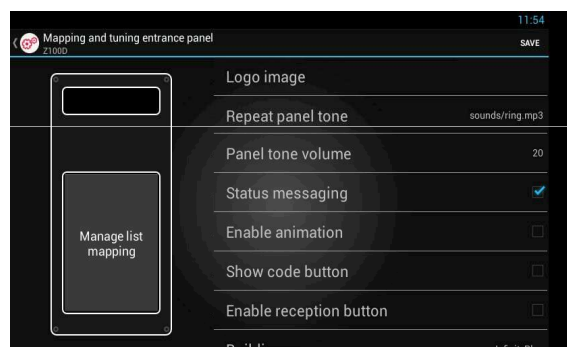
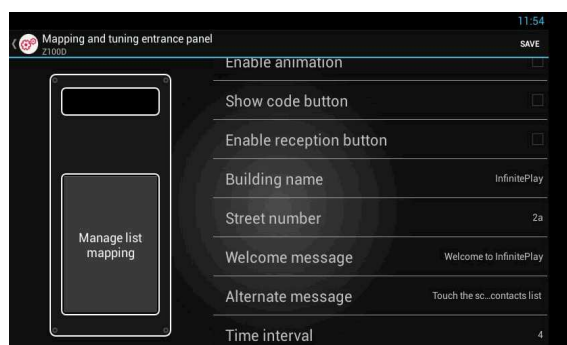
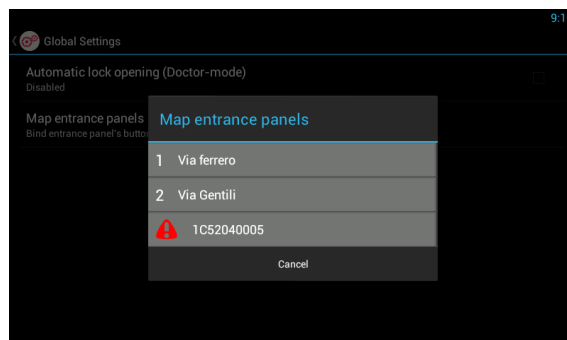

KIT

OPERATING ISTRUCTIONS

1. FUNCTION BAR (BUTTONS ON THE RIGHT)

HOME
RETURN
SETUP
SEARCH

2. VIDEO DOOR PHONE WIDGET

LOCK
LIGHT STAIR
GATE

3. DATA AND TIME

4. METEO (with internet connection)

5. VIDEO DOOR PHONE FUNCTION

Available to the call (green symbol)

Do not disturb (red symbol, choose how long)

ANSWERING A CALL

1.VIDEO DOOR PHONE FUNCTION

2.TO END THE CALL

3.MUTE MICROPHONE

4.TO ANSWERING A CALL

IPCALL VIDEO DOOR PHONE APP

1.VIDEO DOOR PHONE FUNCTION

2.CONCIERGE LIST

INTERCOM CONTACT LIST

ENTRANCE PANEL LIST

LOG ACTIVITIES

3.SETUP / AUDIO SETTINGS

MESSAGING

TO SEND TEXT MESSAGES AND FILES (JPG – PDF) FROM
MONITOR TO CONCIERGE AND FROM CONCIERGE TO MONITOR

THE COMMUNICATION IS ABLE BETWEEN INTERNAL MONITOR
AND CONCIERGE



3

4

1

5

2



1

2

3

4

2

3

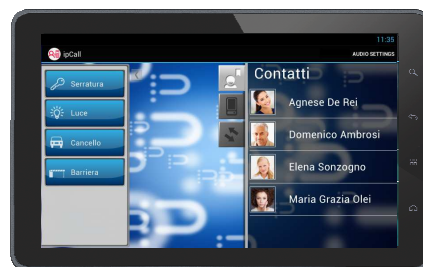

1

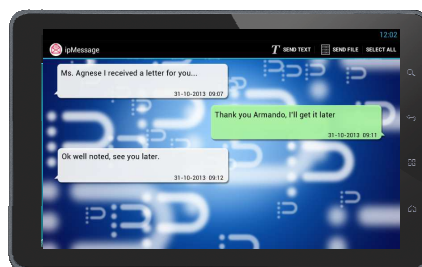

KIT

OPERATION:

Important: For the monitor operation, the ID must have already been programmed. To check this, in all devices

Operating times

The answer and the conversation times depend on the configuration of the corresponding entrance panel parameters.

- Answer time (for entrance panel call): Default value 30 s
- Answer time (for intercommunicating call): 30 s
- Conversation time (for entrance panel call): Default value 120 s
- Self-activation time (for entrance panel call): Default value 30s

Answering a call

A call from the outdoor entrance panel or from an intercommunicating device can be answered during the chime cycle or once it has ended. To answer, press green push button; to end the call, press red push button.

Receiving a door call

The monitor can receive calls from a door call button if connected to terminals M and FP directly. When the door call button is pressed, the monitor emits a different tone to the one used for outdoor entrance panel calls or intercommunicating calls.

Making an intercommunicating call

To make a call to another indoor unit, it is necessary to open the videodoor phone app and choose the name to the contacts list.

Muting the ringtone during a call (Mute function)

When receiving a call from an outdoor entrance panel or from an intercom device, the call ringtone can be muted by pressing button MUTE in home page widget. You can set the mute time (for example 30 minutes)

Door lock command

If you press the lock button by home page widget to send a lock opening command to the entrance panel. The lock is connected to the power supply for security.

Self-start

The videodoor phone is able to recognize the entrance panel or CCTV cameras.

From the entrance list you can make a self-start function for monitoring and conversation.

Calling a concierge station

From the concierge list you can call the concierge service (lobby, management office, guard office)

Alarm and Panic buttons

The monitor can send two alarms to Concierge station. Connecting a button directly to terminals M and AL, you can send an alarm (gas detector, smoke detector) to concierge. If connecting a button directly to terminals M and P, you can send a panic alarm to concierge. This function is available from widget SOS.

Choice a ringtone

Through the settings you can choose between different electronic ringtones.

Ringtone volume adjustment

Through the settings you can choose between different volume levels plus mute.

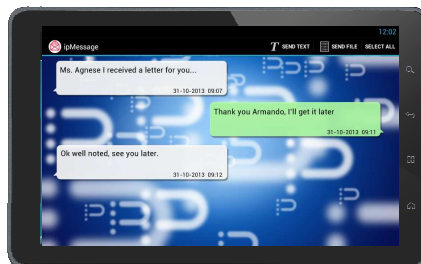
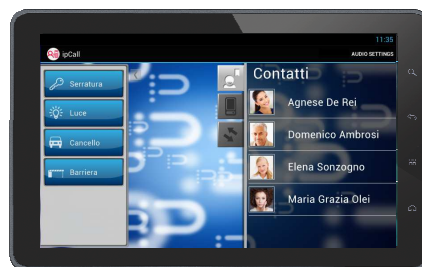

KIT

SINGLE RESIDENCE SYSTEM WITH 7" VIDEO DOOR PHONE AND ONE AUDIO-VIDEO ENTRANCE PANEL



Video door phone

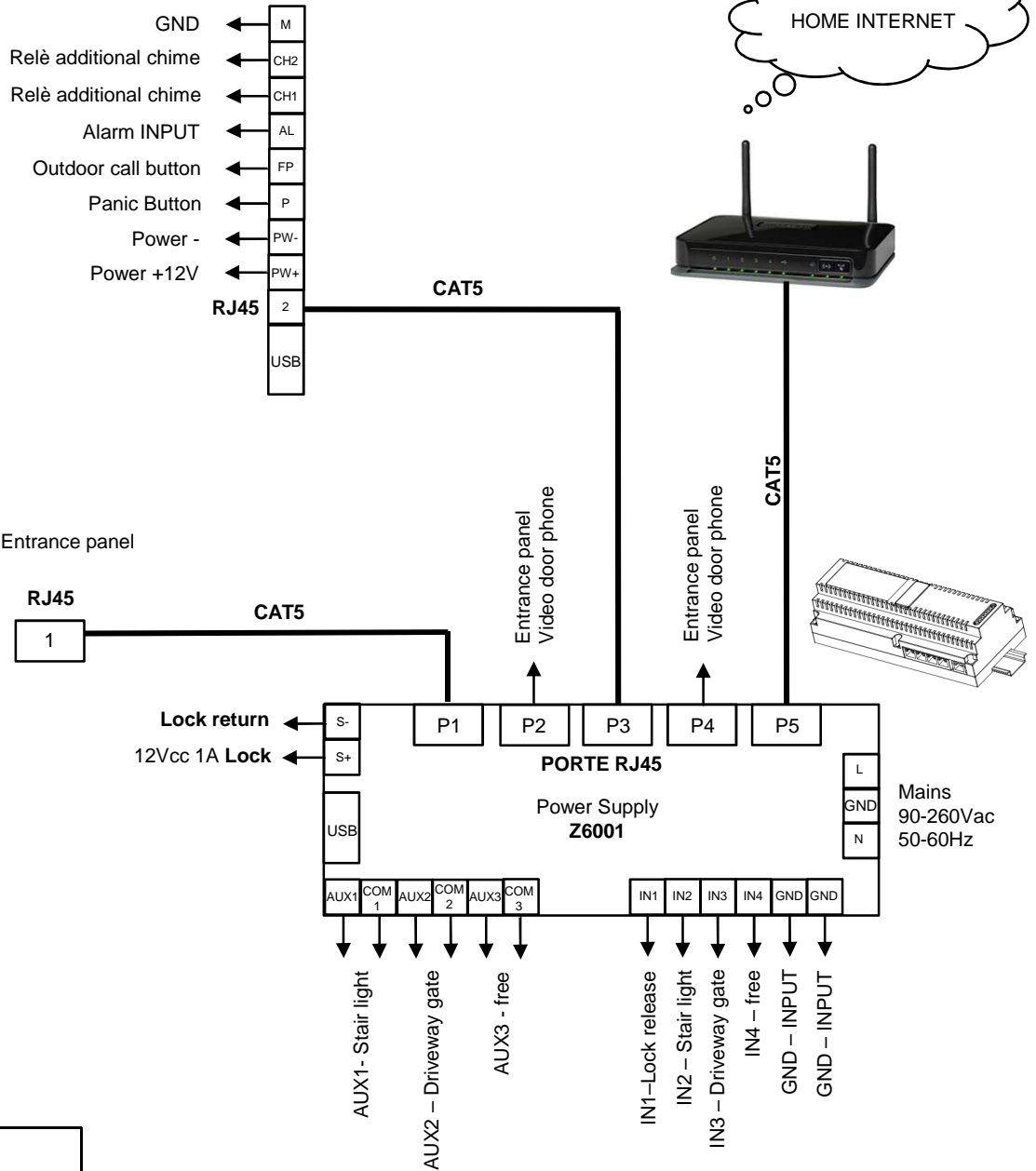

KIT

CONNECTION VARIANTS:

WIRING DIAGRAM ADDITIONAL ELECTRONIC CHIME



Video door phone

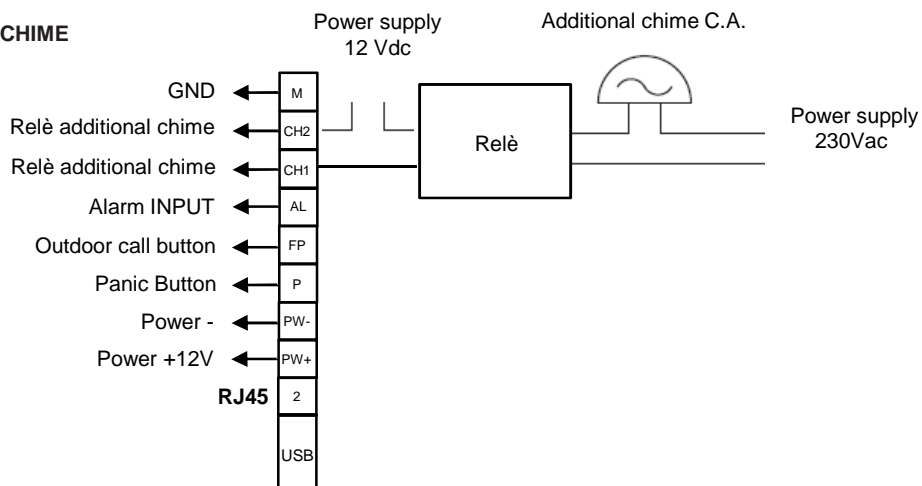

Video door phone

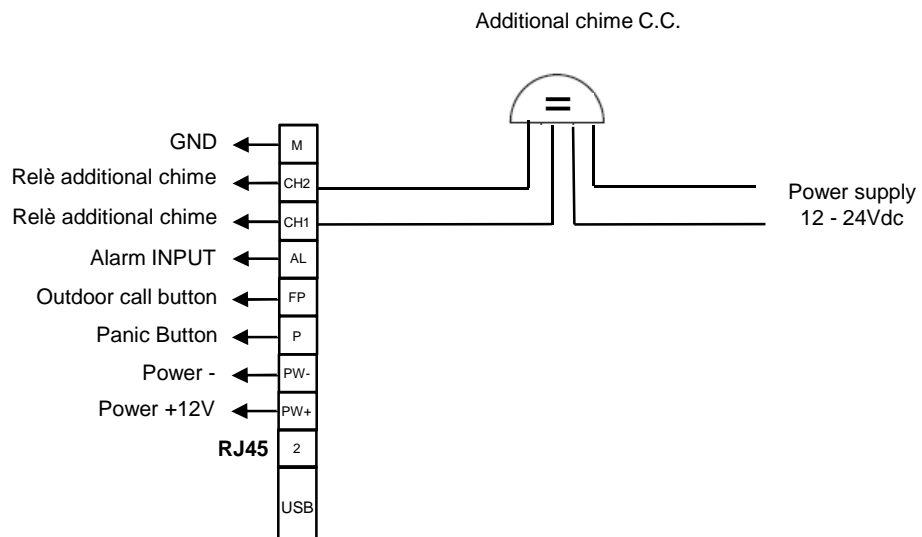

WIRING DIAGRAM DOOR CALL BUTTON



Video door phone

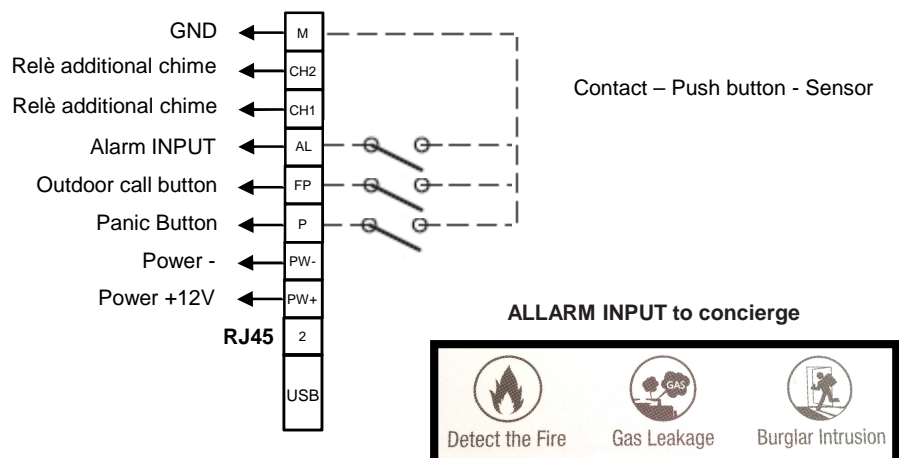

KIT

CONNECTION VARIANTS:

WIRING DIAGRAM DOOR RELEASE CONTROL

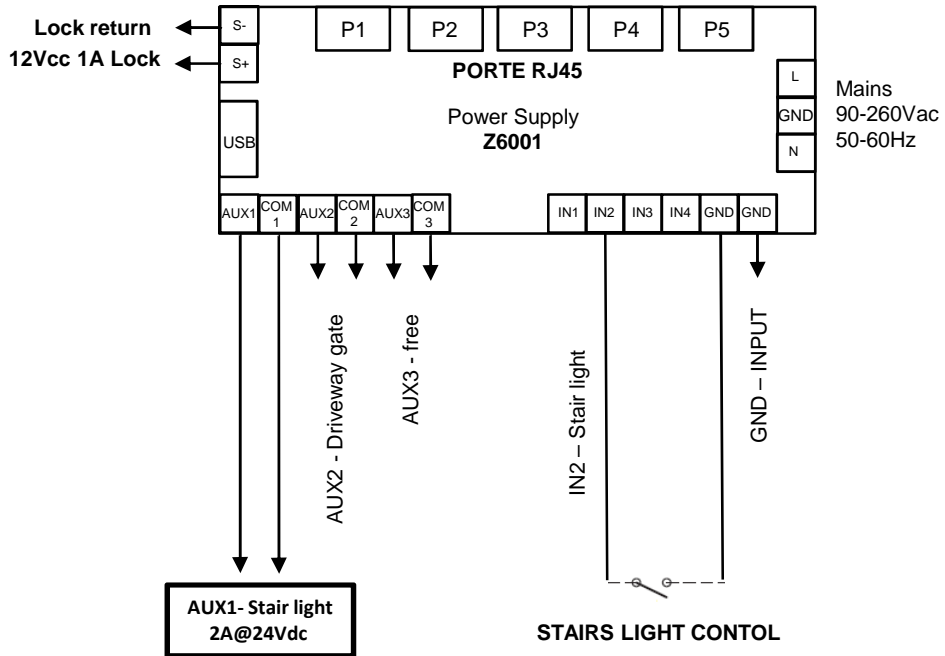

WIRING DIAGRAM DOOR RELEASE CONTROL

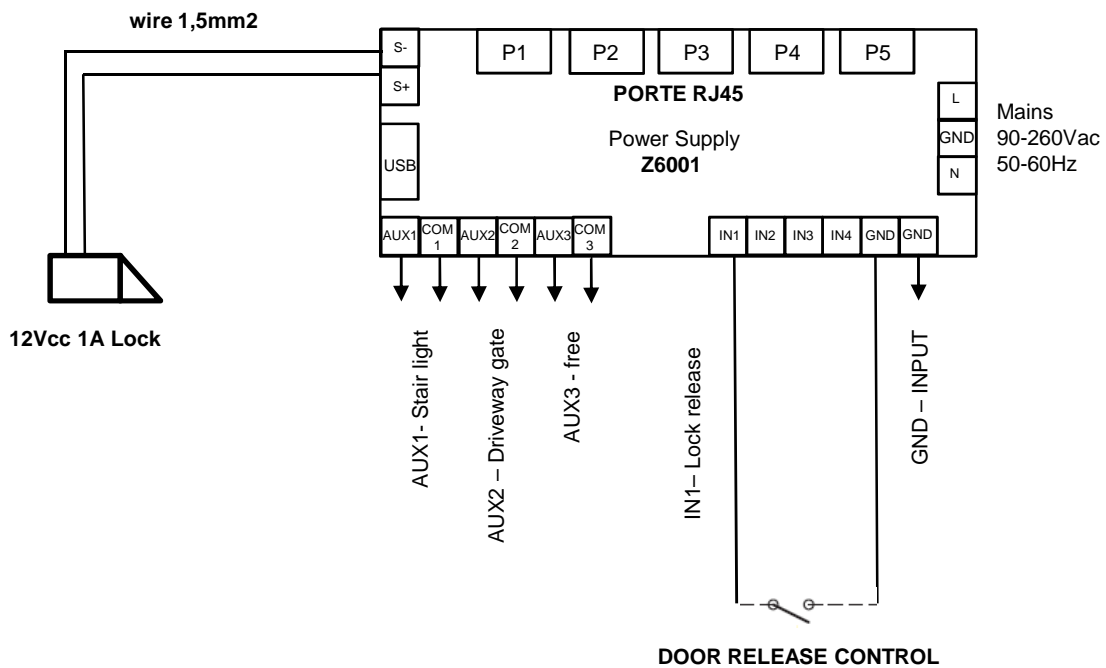



KIT

INSTALLATION NOTE :

KIT

Directive 2012/19/UE (WEEE)

The crossed-out wheelee bin symbol marked on the product indicates that the product must be assigned to a differentiated collection centre for electrical and electronic equipment or returned to the dealer to purchase a new product.

For further details regarding the collection systems available, contact your local waste disposal service.

The user is responsible for assigning the equipment purchased, to the appropriate collection facilities.

Risks connected to substances considered as dangerous (WEEE).

According to the WEEE Directive, these electrical and electronic products contain harmful substances for people and the environment.

It is obligatory treat the recycling of the materials in such way to avoid negative impacts on the environment and people's health.

Adaptation to current regulations allows a correct recycling of which the product is made.



SAFETY INSTRUCTIONS FOR INSTALLERS

This equipment is used in video door entry and home & building automation systems.

The instructions in this document provide important information about safety, installation, use and maintenance of the product.

Verify that the equipments are undamaged, after purchase.

The packaging contains potential dangerous sources for children (screws and dowels).

The installation must respect the current CEI regulations.

It is necessary to install to the power supply a protection bipolar type switch to video door entry system.

Before connecting this equipment verify the output voltage supplied from the distribution network.

Before performing maintenance operations, disconnect the device.

In case of failure or malfunction, disconnect the device and contact the technical assistance centre.

Do not obstruct opening of ventilation or heat exit slots.

The protection bipolar type switch must be located in the main framework of the House.

WARNING:

This equipment must be fixed to the wall according to the installation instructions.

This leaflet must always be attached to the system documentation.



Product is according to EMC Directive 2004/108/EC, LVD 2006/95/EC and RoHS 2011/65/EU.



This product is Listed by UL. Representative samples of this product have been evaluated by UL and meet applicable safety standards. Product is according to UL60950-1 2nd Edition + A1 + A2.

Product is according to IEC 60950-1 2nd Edition + A1 + A2.

*This device complies with part 15 of the FCC Rules. Operation is subject to the following two conditions:
(1) This device may not cause harmful interference, and
(2) this device must accept any interference received, including interference that may cause undesired operation.*

This Class[B] device complies with ICES-003 Issue 5.

CAN ICES-3 (B)/NMB-3(B)



INFINITEPLAY

InfinitePlay S.r.l.

Via Monte Grappa, 25
31020 Villorba (TV) ITALY
Tel. 0422 350680
Fax. 0422 446958
www.infiniteplay.com



ENG
18901074 – RL01 10 16
INFINITEPLAY - ITALY